

Bio SB TintoRetriever Pressure Cooker

Nucleic Acid & Epitope Retrieval System

Instruction Manual

Index

Topic	Page
Description & Features	Page 2
Main Technical Parameters	Page 3
Safety Requirements	Page 4
Parts & Features	Page 5
Installation	Page 6
Operating Procedures	Page 7
Cleaning & Storage	Page 9
Temperature Settings	Page 10
Applications for IHC	Page 11
Troubleshooting & Contact info	Page 12
QC Certificate	Page 13



Figure 1 - TintoRetriever system with slide racks and reagent holders.

1. DESCRIPTION & FEATURES

Most formalin-fixed paraffin embedded tissues require an antigen retrieval step prior to any immunochemical staining. The antigen retrieval step breaks some of the methylene bridges that cross-link proteins in formalin-fixed tissue and allow antibodies to bind to unmasked epitopes.

Heat induced epitope retrieval and nucleic acid retrieval steps are most often performed using a conventional pressure cooker or a microwave oven. The Bio SB TintoRetriever is a precision-controlled heat source capable of maintaining a constant and reliable temperature while minimizing the potential for evaporation of the working solution under HIER procedure conditions.

The TintoRetriever Pressure cooker is recommended for use in both Immunohistochemistry (IHC) and In-Situ Hybridization (ISH) protocols,

TintoRetriever Applications (Pictured on Cover)

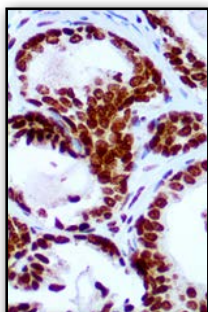

IHC
p40 RMab
BSB 2072

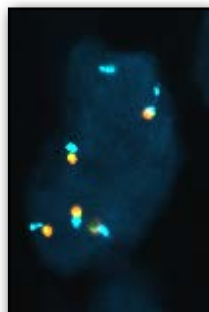

FISH
ALK/EML4 TriCheck
Z-2117-200

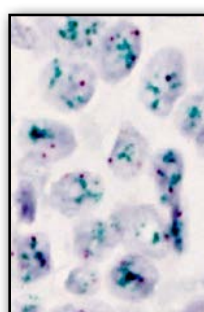

CISH
HER2/CEN 17
3022-40

- Rapid Heat Retrieval
- Multiple Temperature Settings
- Use in IHC & ISH Applications
- Low Reagent Use
- Holds 96 Slides Per Run
- Cost Effective HIER Solution

2. MAIN TECHNICAL PARAMETERS

- Power Requirements: AC110V, 60Hz, 1000W
- Dimensions: 320mm x 320mm x 340mm (W x D x H)
- Packaged Dimensions: (330mm x 330mm x 360mm) (W x D x H)
- Weight: 12.6 lb (5.7 Kg)
- Operational Temperature: 60°C – 121°C
- Operational Humidity: 85%
- Chamber Working Temperature: 121 °C
- Chamber Working Pressure: 15 PSI (103 kPA, 1.03 bar, 1 kg/cm²)

NOTE:

TintoRetriever Pressure Cooker is intended to be run with AC110V, 60Hz,1000W.

If there is a need to operate this instrument at AC 220V, Bio SB recommends using a transformer with the following specifications.
 Output: 110Volts and a minimum of 1000Watts



Figure 2 - Recommended transformer for use in countries with 220V standard electricity.

3. SAFETY REQUIREMENTS:



CAUTION: Read the user manual fully before use and pay particular attention to sections containing this symbol. Please carefully read user manual before installation, operation, maintenance and repairing to avoid personal injury and damage to the Instrument.

- 3.1 Do not immerse electrical cord, plugs or main cooker body into water or other liquids to avoid electrical shock and/or fire hazard.
- 3.2. Do not touch hot surfaces of the pressure cooker. Use handles only.
- 3.3. Operate the pressure cooker only with properly closed lid.
- 3.4. Do not fill working chamber with more than recommended volume of water.
- 3.5. Never attempt to open the lid while the unit is operating. Wait until the unit is switched off and pressure has been completely released. If the lid is difficult to rotate, this indicates that the working chamber still has excess pressure.
- 3.6. Never move the pressure cooker while operating it.
- 3.7. Exercise care when releasing excess pressure from the cooker; improper technique may result in scalding or injury.
- 3.8. Unplug from outlet when not in use or cleaning/servicing.
- 3.9. Do not use under hanging shelves, cabinets etc or damage may occur.
- 3.10. Always check the pressure limit valve for possible clogging before each run.

TintoRetriever Components

Number	Component
1	Pressure Limit Valve
2	Red Pressure Indicator
3	Push Rod
4	Sealing Ring
5	Working Chamber
6	Condensation Collector
7	Handle
8	Main Body
9	Heating Plate
10	Base
11	Power Cord
12	Lid Handle
13	Lid
14	Sealing Ring Supporting Cover
15	Rubber Grommet
16	Upper Ring
17	Control Panel
18	Trivet

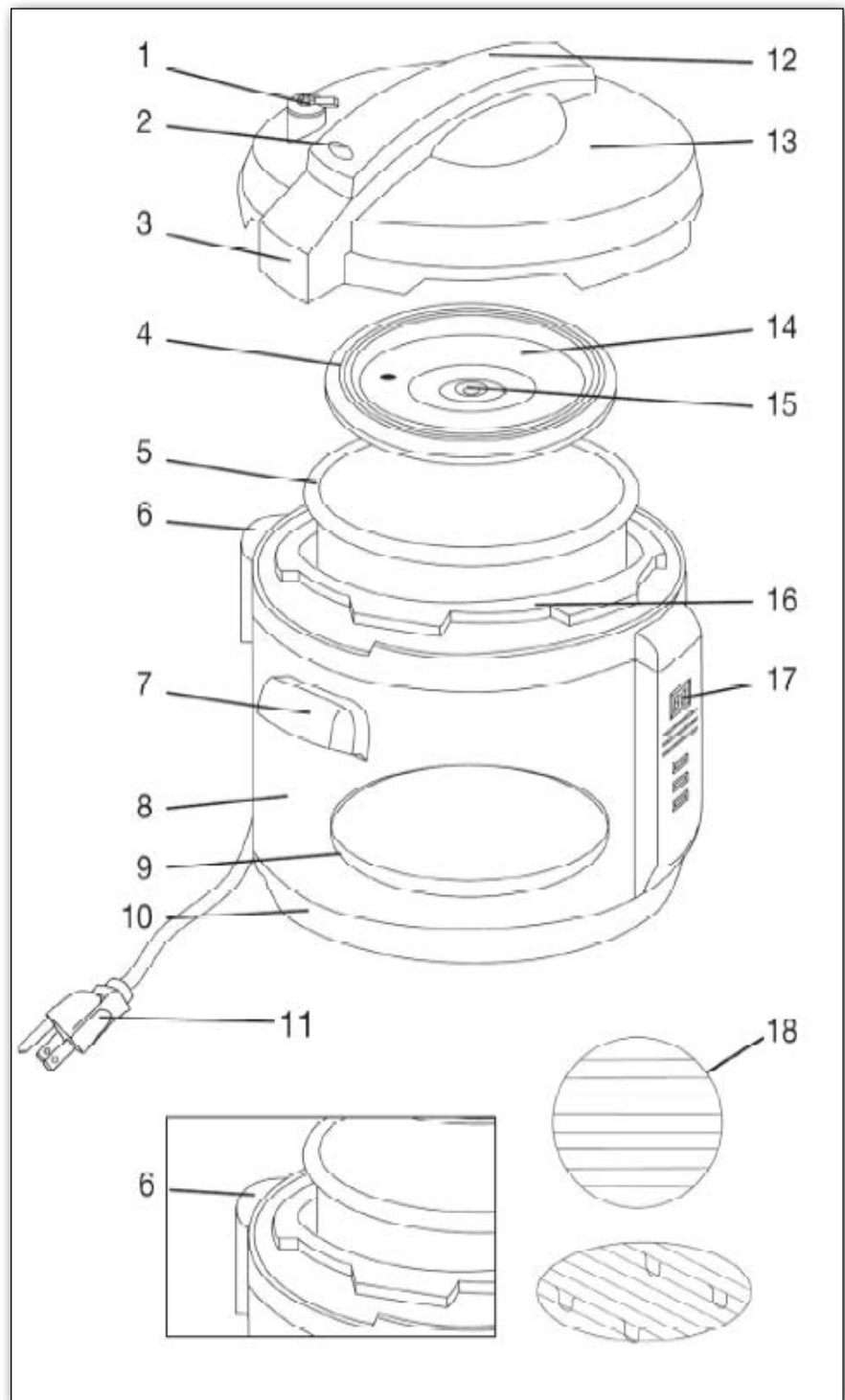

Figure 3 - TintoRetriever Parts

5. INSTALLATION:

5.1. Remove TintoRetriever Pressure Cooker from packaging material and inspect for any damage. Be sure all parts have been included before discarding any packaging material. If any signs of mechanical damage to the Digital Pressure Cooker have been observed, do not use it and contact Bio SB (see page 12 for contact details).

5.2. Thoroughly clean all parts with a towel/rug and Place the Digital Pressure Cooker on a clean, flat surface.

5.3. Place the condensation collector in the rear of the main cooker body until it clicks into place as shown below:

NOTE: Even though pressure limit valve will have a loose fit, it is safely secured.

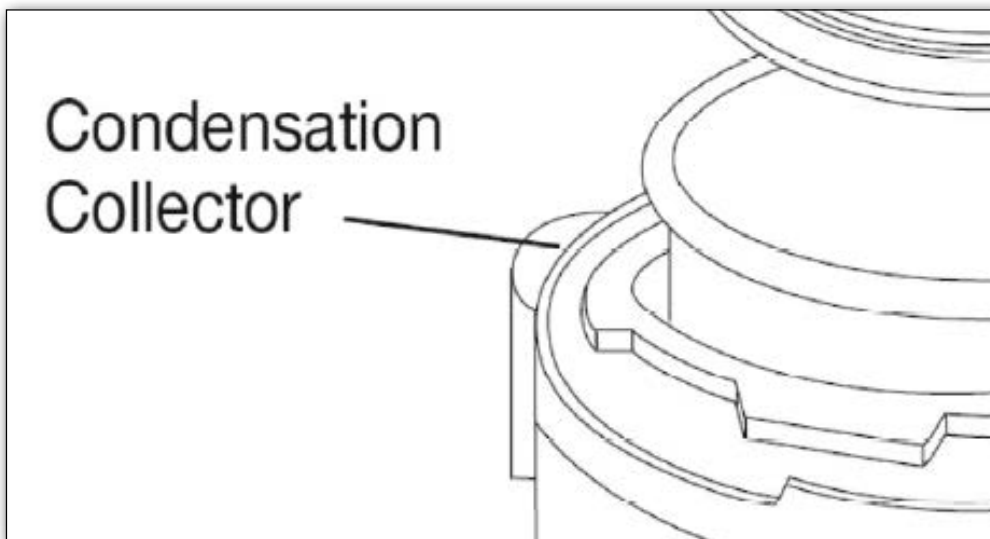

Figure 4 - Condensation Collector Placement

Place the pressure limit valve on the lid as shown below:

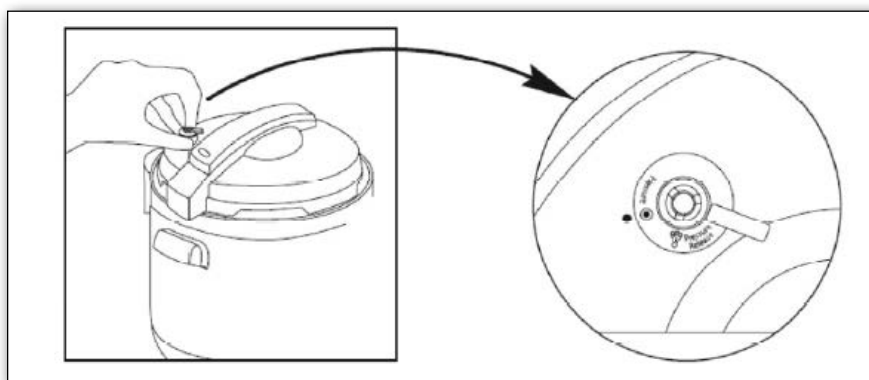

Figure 5 - Setting Instrument to Pressure setting

6. OPERATION PROCEDURES:

- 6.1. Place clean and dry working chamber and dry the main body. Make sure that no water or any other liquid is present inside the main body. Any liquid inside the main body may cause a malfunction with permanent damage, as well as cause a **SERIOUS HEALTH AND/OR FIRE HAZARD**.
- 6.2. Position the trivet the inside working chamber (legs down) and pour approximately 500 ml to 1000 ml of water into the working chamber to barely cover the trivet's surface.
- 6.3. Prepare the reagent holder (BSB 7009) with slides in slide rack (BSB 7010) and gently fill the container with working concentration of HIER solution. We recommend Bio SB ImmunoDNA Retriever with Citrate (BSB0023, BSB0020, BSB0021, BSB0022) or with EDTA (BSB0033, BSB0030, BSB0031, BSB0032).
- 6.4. Place the prepared container inside the working chamber on top of the trivet. Make sure that the bottom of the container makes good contact with water in the working chamber.
- 6.5. Place and secure the lid onto the cooker's main body. This is done by putting the lid into place atop the cooking chamber with the red pressure valve on the left and turning counter clockwise to secure in place.
- 6.6. Position the pressure limit valve into the "pressure" position (see below figure).

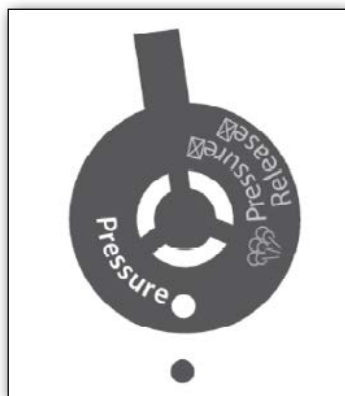

Figure 6 - Pressure cooker in pressure mode



Figure 7 - Pressure cooker in pressure release mode

6. OPERATION PROCEDURES (Continued):

6.7. Plug the power cord into an outlet.

6.8. Press the MENU button on the control panel until the desired indicator light is lit.

6.9. Press the TIME button until the desired time is lit. Bio SB recommends a 15 minute time setting for proper epitope or nucleic acid retrieval (see page 11).

If needed, press the START/CANCEL button twice to reset timer and then set new desired time.

NOTE: Timer will count time accurately only if used with 60 Hz electrical supply.

6.10. Press the START/CANCEL button to start the procedure. The red pressure light will flash. As the pressure and temperature increases, the red pressure valve on top of the lid will rise and stay in place until the pressure is eventually released.

NOTE: The timer will start counting down only after unit reaches the preset temperature and pressure.

6.11. At the end of the set time, the unit will beep and automatically switch to the “keep warm” setting until the START/CANCEL button is pressed again (see 6.8).

NOTE: Do not keep slides under “keep warm” conditions for an extended amount of time as it will affect performance of your nucleic acid/epitope retrieval procedure.

6.12. Position the pressure limit valve into the “release” position.

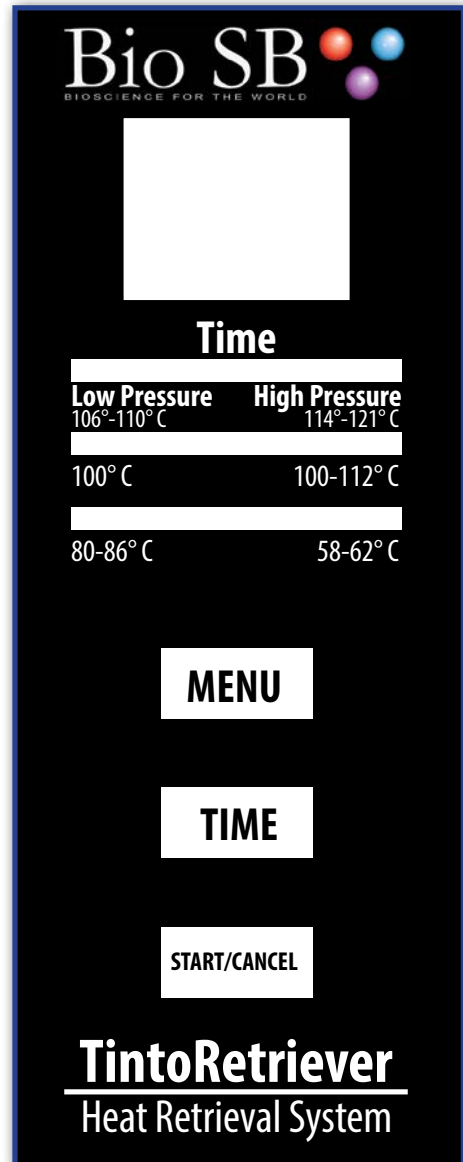



Figure 8 - Front Panel of TintoRetriever



Figure 9 - Valve in “Pressure Release” position

 **CAUTION!** Steam coming out of pressure limit valve can cause a **SERIOUS HEALTH HAZARD**. Avoid scalding by wearing suitable protective clothing and exercising extra caution.

6.13. Confirm that the red pressure valve dropped and remove the lid by turning it clockwise. Open and Lift the working chamber.

6.14. Remove the container with the slides from the working chamber. Allow slides to cool for 15-20 minutes. Proceed with slide treatment as recommended by your protocol.

Be aware that container and inner parts of cooker will be extremely hot. Avoid **SERIOUS HEALTH HAZARD** (scalding or burns) by wearing suitable protective clothing and exercising extra care.

7. CLEANING AND STORAGE

7.1. Wait until the working chamber, the water inside chamber and the trivet have been cooled to a room temperature.

7.2. Remove the working chamber from cooker and remove the trivet from the working chamber.

7.3. Inspect the main body and remove any water/residue from inside or outside with a clean dry paper towel/rug. Do not immerse the main body in water or pour water onto it.

7.4. Dispose the water from the working chamber and dry the working chamber and trivet with clean paper towel/rug. Never use harsh chemicals or scouring pads.

7.5. If needed, disconnect the condensation collector, remove any water, and dry it with clean paper towel/rug.

7.6. If needed, dry the lid and the gaskets with a clean towel/rug. Never use harsh chemicals or scouring pads.

7.7. Connect the condensation collector back to the main body, place the working chamber back inside the main body, place the trivet inside the instrument and place lid on top of the main body. Protect from heat, water, snow, mechanical and electromagnetic shock.

NOTE: Do not lock the lid to allow any residual moisture to escape internal parts of cooker.

8. TINTORETRIEVER TEMPERATURE SETTINGS

High Pressure

Temperature (°C)	
Pressure	114°-121°C

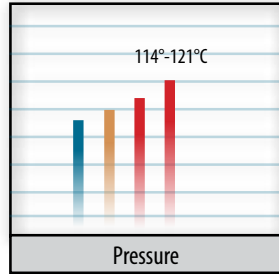

Low Pressure

Temperature (°C)	
Pressure	106°-110°C

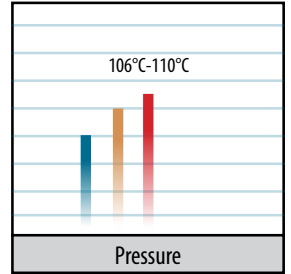

106-112°C

Temperature (°C)	
Pressure Release	Pressure
100°C	106°-112°C

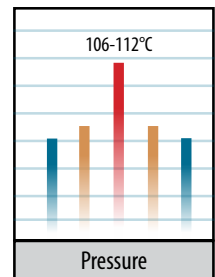
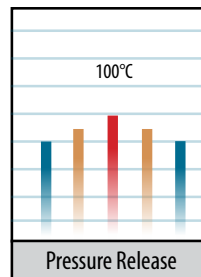

104-110°C

Temperature (°C)	
Pressure Release	Pressure
100°C	104°-110°C

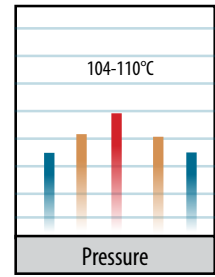
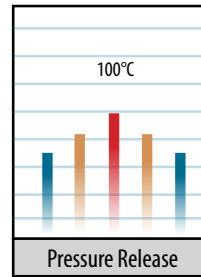

80-86°C

Temperature (°C)	
Pressure Release	Pressure
80-86°C	80-86°C

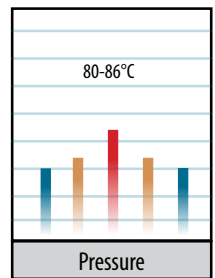
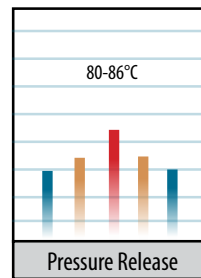

58-62°C

Temperature (°C)	
Pressure Release	Pressure
58-62°C	58°-62°C

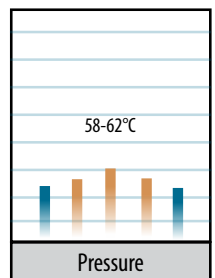
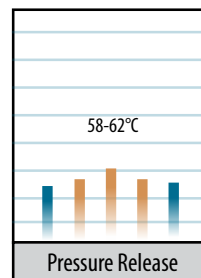

9. TINTORETRIEVER IN THE LABORATORY

The TintoRetriever is a rapid epitope and nucleic acid retrieval system which can be used in a variety of applications in the modern pathology lab.

The Bio SB TintoRetriever comes pre-programmed with 6 temperature settings that can be used for deparaffinization, epitope retrieval, or nucleic acid retrieval (ISH).

This section will focus on tips and recommended settings for the TintoRetriever in a clinical or research setting.

IHC Epitope Retrieval & ISH Nucleic Acid Retrieval 1

For formalin-fixed paraffin-embedded (FFPE) tissue sections, the High Pressure setting with a time of 15 minutes is recommended for thorough heat permeabilization of tissue. We recommend using Bio SB Immuno/DNA Retriever with Citrate or Immuno/DNA Retriever with EDTA for IHC/ISH protocols.

Tissues prone to detachment

Should tissues detach after using the “High Pressure” setting, it is recommended that tissues are mounted using Bio SB Hydrophilic Plus Slides (BSB 7028). Hydrophilic Plus Slides prevent tissue detachment while promoting reagent dispersion.

Tissue Microarrays 2

Tissue Microarrays (or TMA's) typically need gentler epitope retrieval methods than those used with whole tissue sections. At Bio SB, our 11-core NH-TMA (BSB 0297) and 23-core NH-TMA's (BSB 0298) undergo epitope retrieval using the **100°C Setting**. Additionally, the Bio SB TintoRetriever PT module has gentler epitope retrieval settings (BSB 7030), and may be ideal for labs that utilize TMA's.

Deparaffinization Hot Rinse (Tinto DP1 & 2) 3

For non-toxic deparaffinization and hot rinsing of slides, it is recommended you use the 58-62° setting on the TintoRetriever. We recommend TintoDeparaffinator 1 & 2 (BSB 0134 - BSB 0137) as a substitute for Xylene and alcohol based deparaffinization.

Time	
Low Pressure 106°-110° C	High Pressure 114°-121° C
100° C	100-112° C
80-86° C	58-62° C

Figure 10 - Pre-programmed temperature settings



Figure 11 - Hydrophilic Plus Slides
BSB 7028

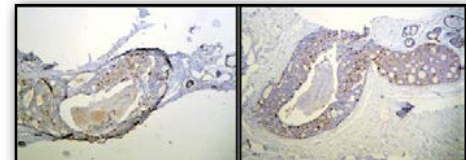

Figure 12 -Tissue Detachment on a Hydrophobic Slide (Left) vs. Hydrophilic Slide (Right)

8. TROUBLESHOOTING

Problem	Cause	Solution
Lid does not lock	The ring is not properly installed	Reinstall ring
	Red pressure valve is seized by push rod	Push rod down
Can't open lid after steam exhaust	Red pressure valve is up	Press red valve down or wait for temperature to drop
Steam escapes from the rim of lid	No sealing ring was installed	Install the sealing ring
	Sealing ring worn out/dirty	Clean/replace ring
	Lid is not locked	Rotate and lock lid
Steam escapes from red pressure valve	Sealing ring on valve is worn out	Replace sealing ring
	Dirty red pressure valve	Clean valve
Red pressure valve will not rise	Pressure limit valve is not placed properly	Set the pressure limit valve to "Pressure" setting
	Not enough water in the working chamber	Add sufficient amount of water to cover trivet
Steam escaping from rim of lid while pressure limit valve is in "Pressure" position	Lid not secured and in lock position	Re secure lid and twist until locked
	Serious malfunction	Stop operation of unit and call customer support

To contact Bio SB customer support

Phone (International): +1-805-453-6631

Phone (United States): 1-800-561-1145

Email: info@biosb.com

Hours of Operation: 9am - 5pm PST, Monday - Friday

Quality Control Certificate

Bio SB ensures that every TintoRetriever undergoes strict quality control procedures, and that every TintoRetriever unit is delivered defect free. Should your TintoRetriever malfunction or otherwise fail under normal use within the first year of ownership, Bio SB will replace the unit at no charge.

Product Name: *Bio SB TintoRetriever Pressure Cooker*

Product Catalog Number: *BSB 7008*

Serial No.: _____

This product is tested and qualified for delivery.

Checked by: _____

Date: _____

